

BW 121100 DC (12V110Ah)

SPECIFICATIONS

Nominal Voltage		12 V
Capacity (25°C)	20HR	110 Ah
	5HR	97 Ah
	1HR	68 Ah
Dimension	Length	330±2mm (12.99inch)
	Width	171±2mm (6.73inch)
	Height	214±2mm (8.43inch)
	Total Height	220±2mm (8.66inch)
Approx. Weight		27.5kg (60.5lbs) ±4%
Terminal type		Z (Pic) or M8
Internal resistance (Fully charged, 25°C)		Approx. 4m Ω
Capacity affected by temperature (10HR)	40°C	102%
	25°C	100%
	0°C	85%
	-15°C	65%
Self-discharge (25°C)	3 month	Remaining Capacity: 91%
	6 month	Remaining Capacity: 82%
	12 month	Remaining Capacity: 65%
Nominal operating temperature		25°C ± 3°C (77°F ± 5°F)
Operating temperature range	Discharge	-15°C ~ 50°C (5°F ~ 122°F)
	Charge	-10°C ~ 50°C (14°F ~ 122°F)
	Storage	-20°C ~ 50°C (-4°F ~ 122°F)
Float charging voltage(25°C)	13.50 to 13.80V Temperature compensation: -18mV/°C	
Cyclic charging voltage(25°C)	14.50 to 15.00V Temperature compensation: -30mV/°C	
Maximum charging current	33A	
Maximum discharge current	800 A(5 sec.)	
Designed floating life(20°C)	10 years	



DIMENSIONS

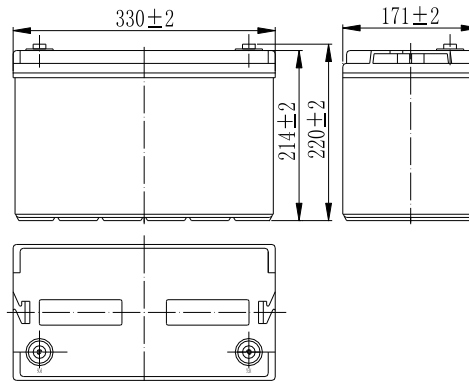

TERMINAL

CONSTRUCTION

Component	Positive plate	Negative plate	Container	Cover	Separator	Electrolyte	Safety valve	Terminal
Raw material	Lead dioxide	Lead	ABS	ABS	AGM	Sulfuric acid	Rubber	Copper

CONSTANT CURRENT DISCHARGE CHARACTERISTICS (A, 25°C)

F.V/TIME	10min	15min	30min	60min	2h	3h	4h	5h	8h	10h	20h
9.60V	240	185	111	68.0	40.2	28.6	23.1	19.7	13.6	11.2	5.93
9.90V	233	180	108	67.0	40.0	28.4	23.0	19.6	13.5	11.2	5.92
10.2V	223	174	105	65.3	39.6	28.2	22.8	19.5	13.4	11.1	5.91
10.5V	213	168	102	63.9	39.0	28.1	22.7	19.4	13.3	11.1	5.87
10.8V	201	159	99	61.9	38.0	27.2	22.0	18.8	12.9	11.0	5.83

CONSTANT POWER DISCHARGE CHARACTERISTICS (WATT, 25°C)

F.V/TIME	10min	15min	30min	60min	2h	3h	4h	5h	8h	10h	20h
9.60V	2590	2029	1240	775	465	336	272	233	161	134	71.2
9.90V	2512	1980	1216	763	463	334	270	232	160	133	71.1
10.2V	2409	1907	1178	744	459	332	268	230	159	133	70.9
10.5V	2305	1842	1150	728	452	330	266	229	158	132	70.4
10.8V	2175	1745	1108	706	440	320	258	222	153	131	70.0

Note: The above characteristics data can be obtained within three charge/discharge cycles.

Discharge Characteristics (25°C)

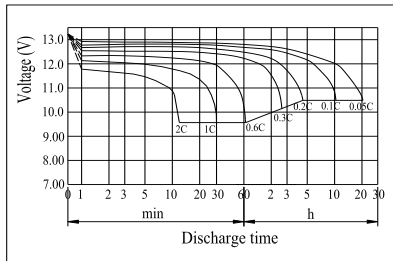

Charging Characteristics (25°C)

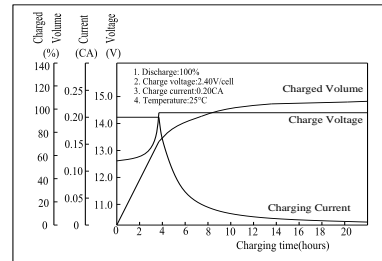

The Relationship for Open Circuit Voltage and Residual Capacity (25°C)

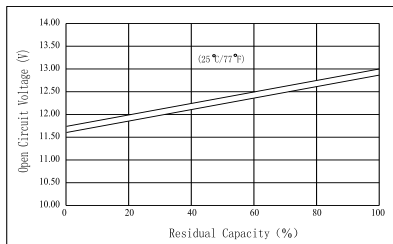

The Relationship for Charging Voltage and Temperature

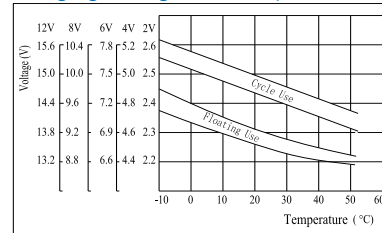

Floating Life on Temperature

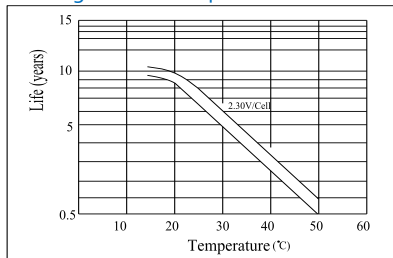

Cycle Life on D.O.D (25°C)

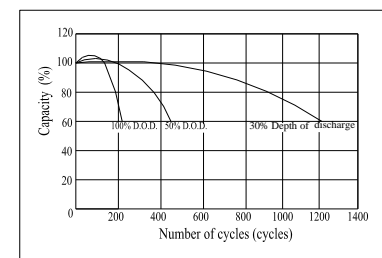

Effect of Temperature on Capacity

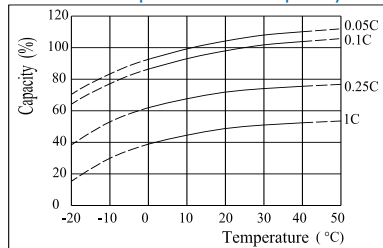

Self-discharge Characteristics

